

NOVARA

by Tecnitubo



ARQUIVAMENTO | FILING | ARCHIVO

GUARDARE



Espaço para acontecer.

Em tempos nos quais agilidade e dinamismo são fundamentais, **Guardare** é mais que uma solução para organização, é a forma mais eficaz de otimizar o tempo e selecionar tudo o que realmente é relevante para o dia a dia.

A space for things to happen.

In times when agility and dynamism are key, **Guardare** is more than a solution for organization, it is the most effective way to optimize time and select all that is really relevant for everyday life.

Espacio para trabajar.

En tiempos en que la agilidad y el dinamismo son fundamentales, **Guardare** es más que una solución para la organización, es la forma más eficaz de optimizar el tiempo y seleccionar todo lo que es realmente importante para el día a día.

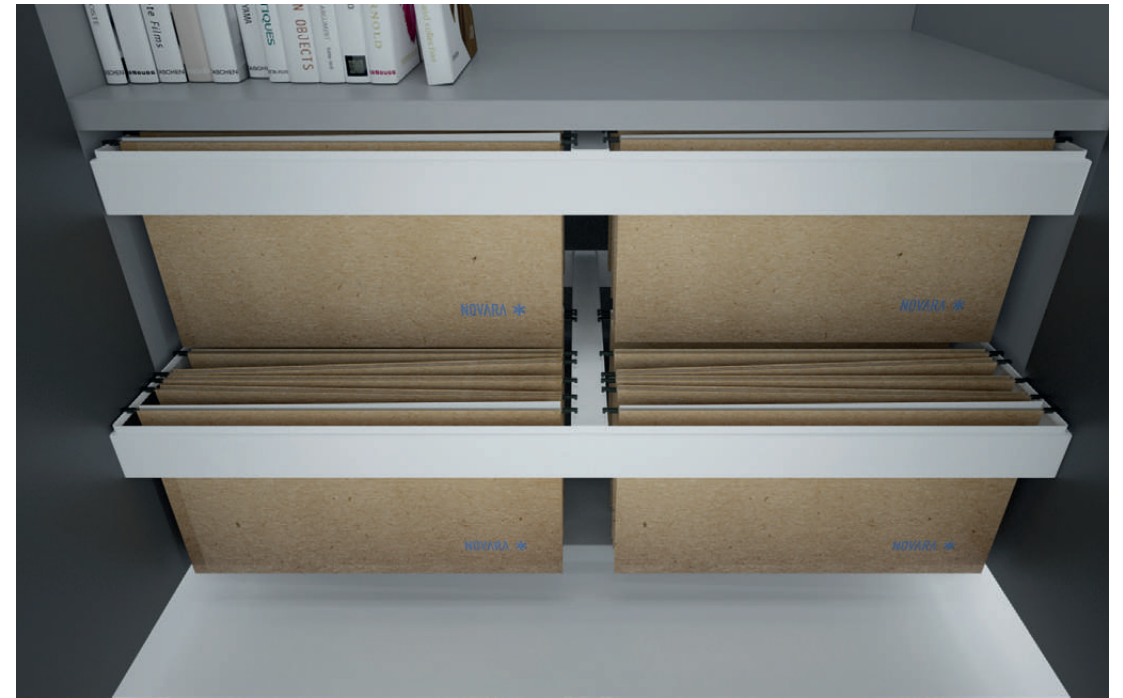
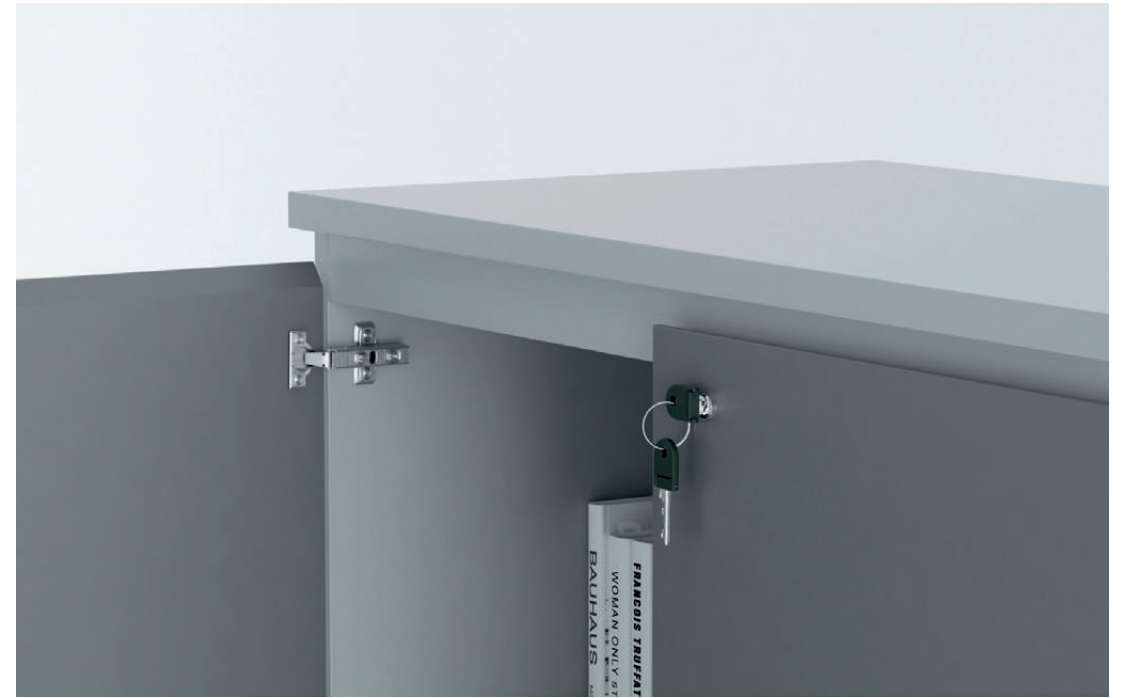

ARMÁRIO | CABINET | ARMARIO

01 porta baixo | 01 door low | 01 puerta bajo

Vista superior
Top View | Vista superior

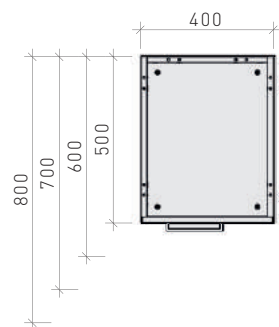
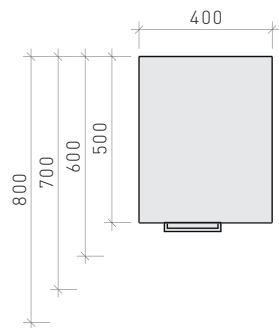

Vista frontal
Front View | Vista frontal

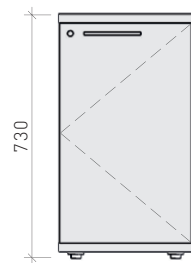

ARMÁRIO | CABINET | ARMARIO

02 porta baixo | 02 door low | 02 puerta bajo

Vista superior
Top View | Vista superior

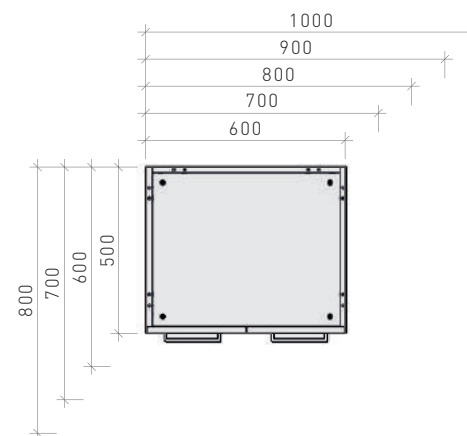
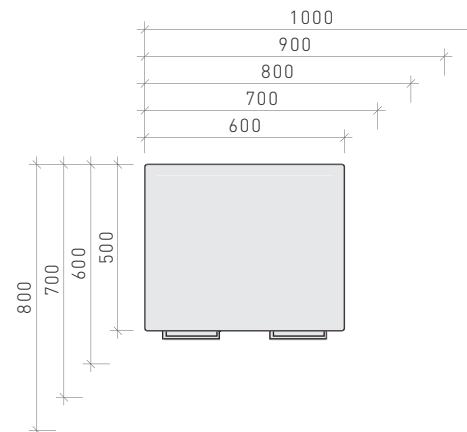

Vista frontal
Front View | Vista frontal

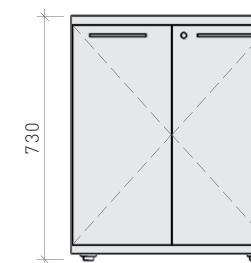

Quando o puxador for modelo cava, será na horizontal
When the handle is cava model, it will be horizontal | Cuando el tirador sea del modelo cava, será en la horizontal

Os armários baixos e médios não contemplam prateleira interna, devem ser solicitadas separadamente
Low and medium cabinets do not include internal shelf, it must be ordered separately | Los armarios bajos y medianos no contienen estante interno, hay que solicitarlo por separado

Os armários altos e grandes contemplam uma prateleira fixa interna
High and large cabinets include an internal fixed shelf | Los armarios altos y grandes contienen un estante interno fijo

GUARDARE

ARMÁRIO| CABINET | ARMARIO

02 portas médio e alto | 02 doors low and high | 02 puertas mediana y alta

Vista superior
Top View | Vista superior

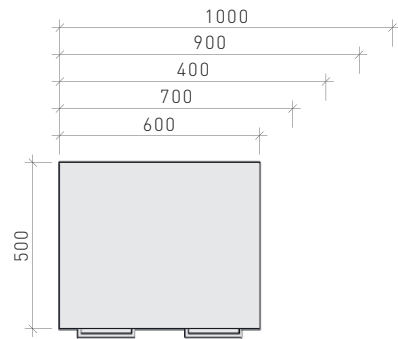

Vista frontal
Front View | Vista frontal

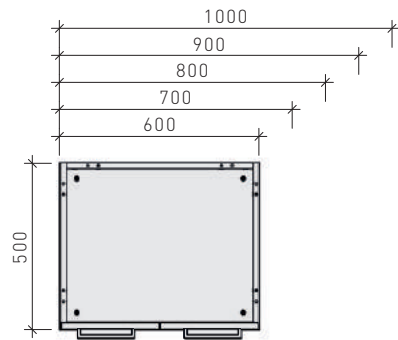
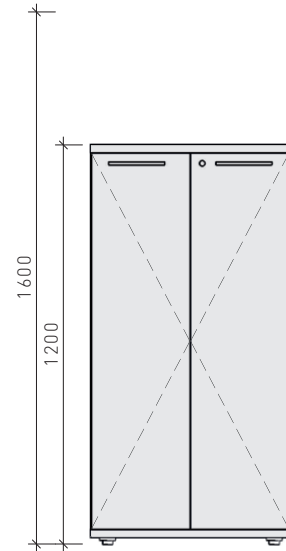

ARMÁRIO| CABINET | ARMARIO

02 portas grande | 02 doors large | 02 puertas grandes

Vista superior
Top View | Vista superior

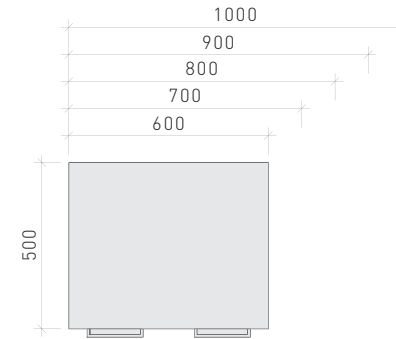

Vista frontal
Front View | Vista frontal

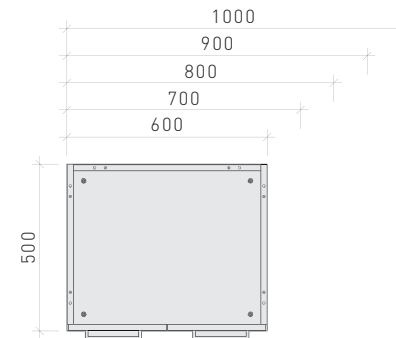
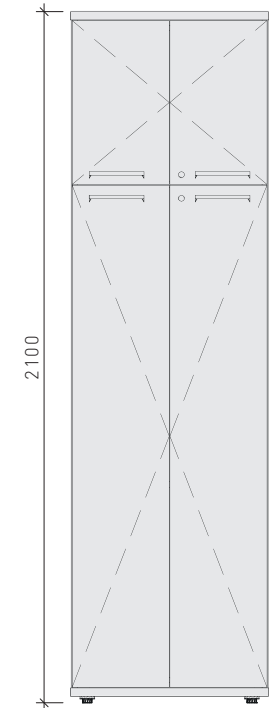

ARMÁRIO | CABINET | ARMARIO

Aberto baixo | Open low | Abierto bajo

Vista superior
Top View | Vista superior

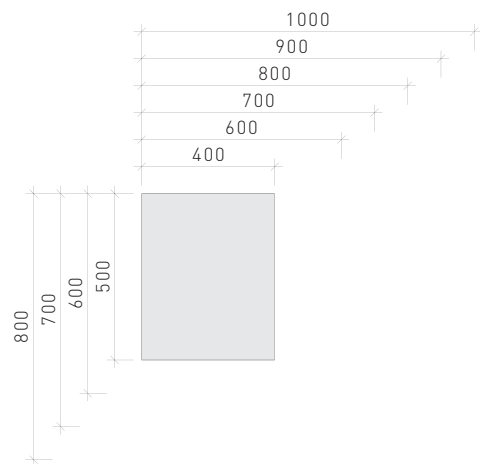

Vista frontal
Front View | Vista frontal

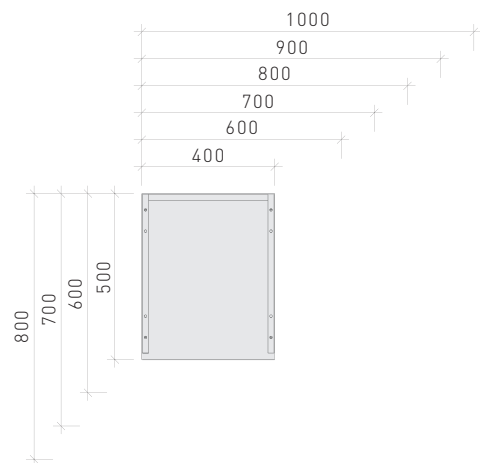
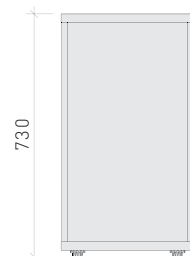

ARMÁRIO | CABINET | ARMARIO

Aberto médio e alto | Open medium and high | Abierto mediano y alto

Vista superior
Top View | Vista superior

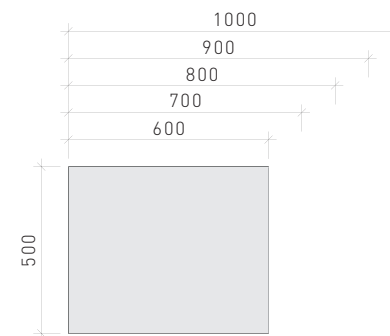

Vista frontal
Front View | Vista frontal

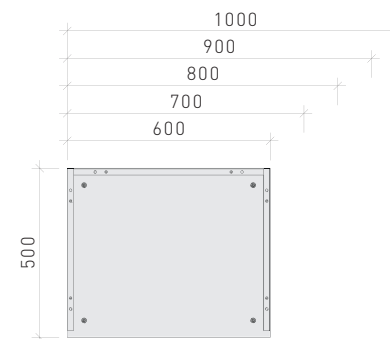
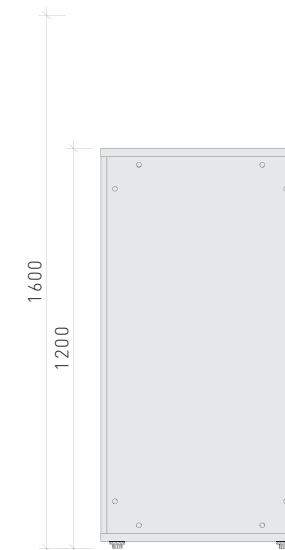

GUARDARE

ARMÁRIO | CABINET | ARMARIO

Aberto grande | Open large | Abierto bajo

Vista superior
Top View | Vista superior

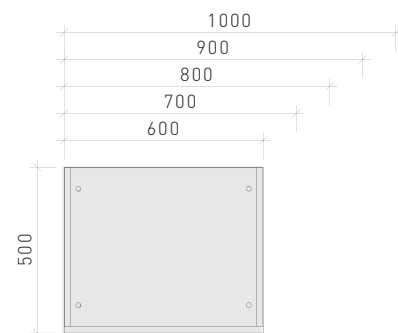
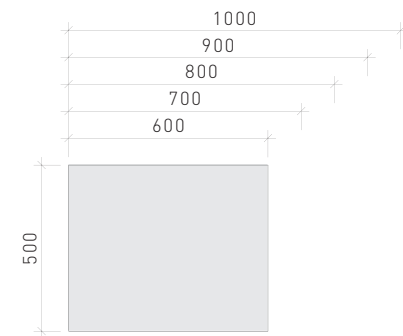

Vista frontal
Front View | Vista frontal





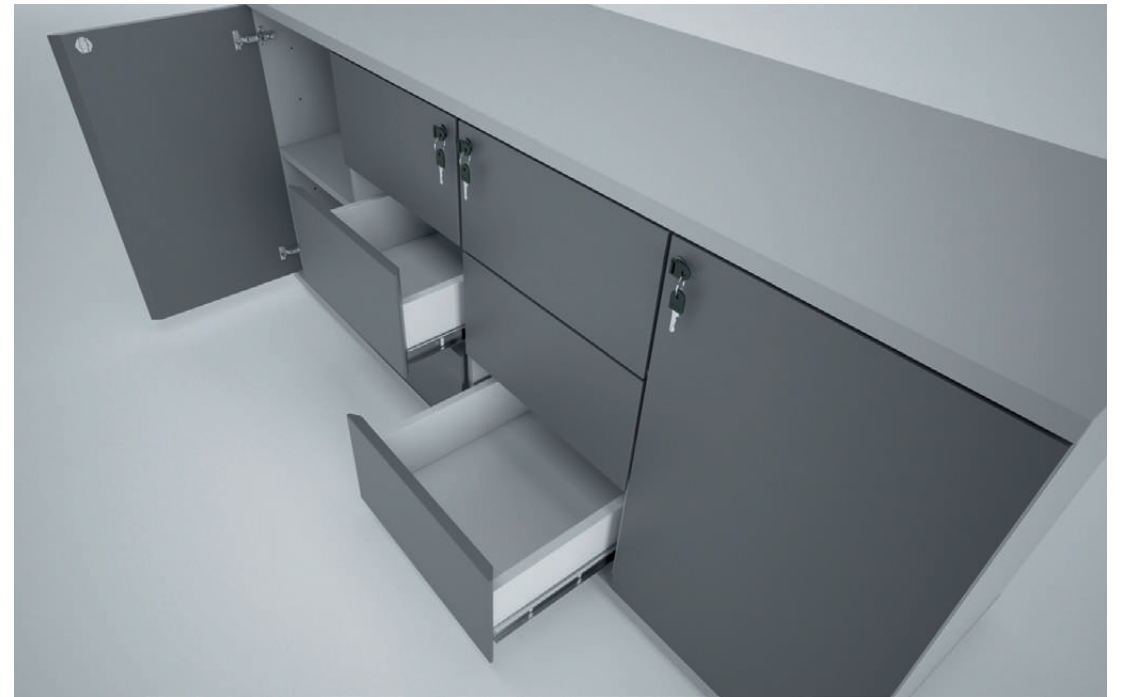
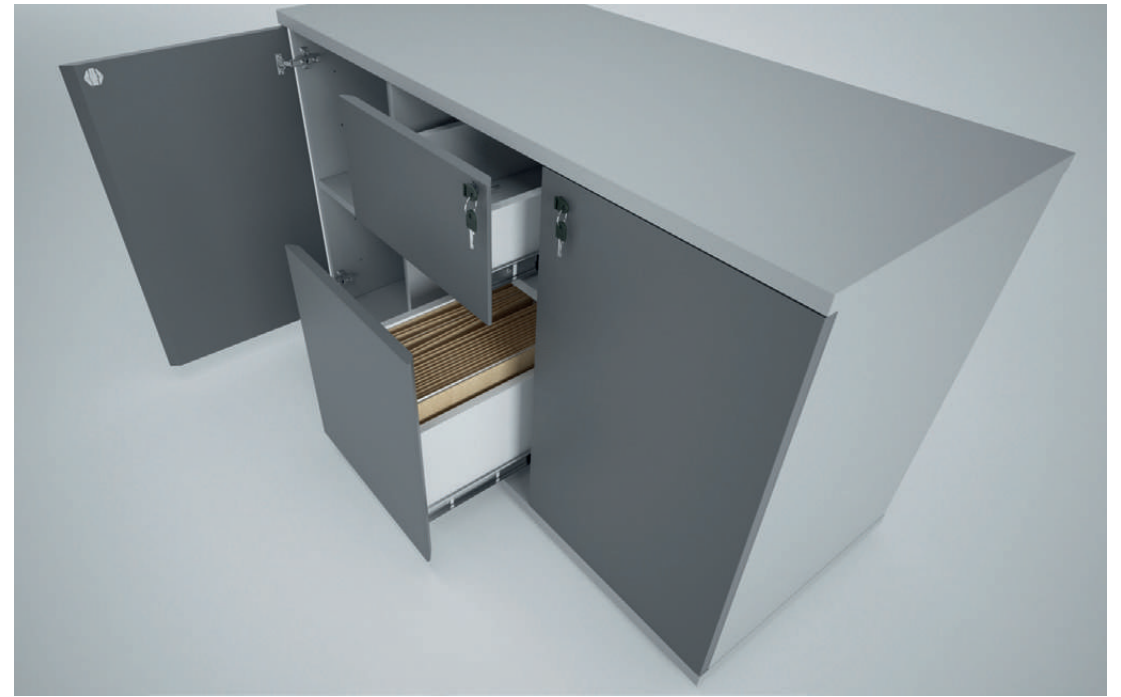

ARMÁRIO| CABINET | ARMARIO - 03 portas baixo
03 doors low | 03 puertas bajo

Vista superior
Top View | Vista superior

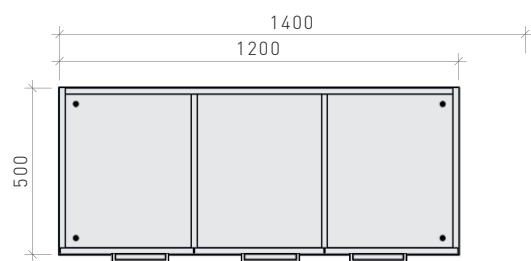
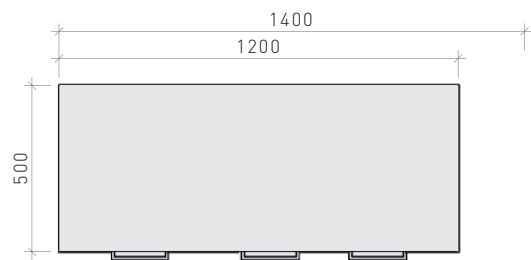

Vista frontal
Front View | Vista frontal

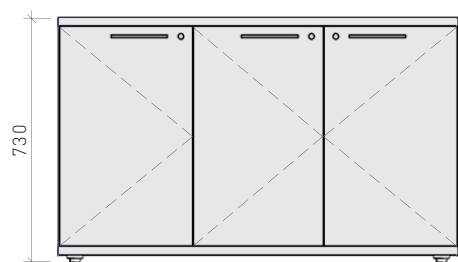

ARMÁRIO| CABINET | ARMARIO - 02 portas e 01 nicho central
02 doors and 01 central niche | 02 puertas y 01 nicho central

Vista superior
Top View | Vista superior

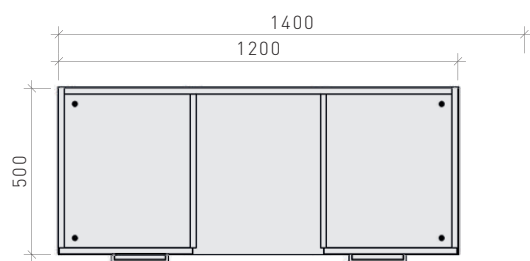
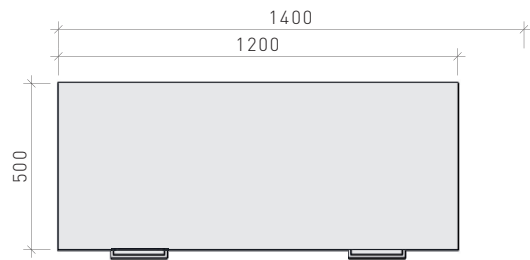

Vista frontal
Front View | Vista frontal

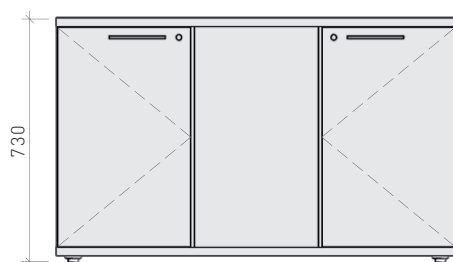

ARMÁRIO| CABINET | ARMARIO - 02 portas e 03 gavetas baixo
02 doors and 03 drawers low | 02 puertas y 03 cajones bajo

Vista superior
Top View | Vista superior

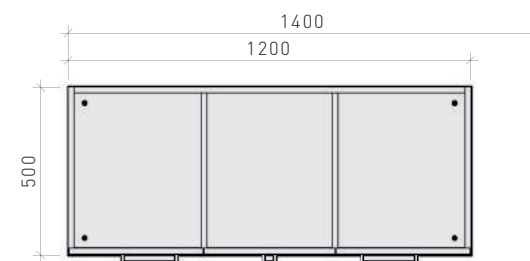
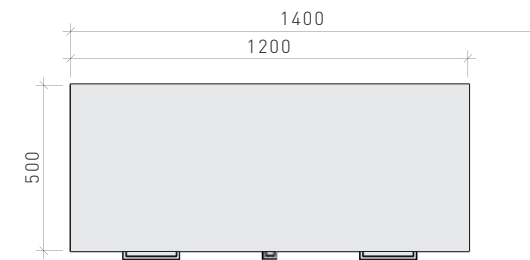

Vista frontal
Front View | Vista frontal

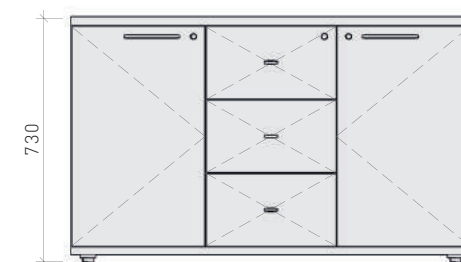

Quando o puxador for modelo cava, será na vertical
When the handle is cava model, it will be vertical
Cuando el tirador sea del modelo cava, será en la vertical

	Prateleira Externa Shelf External Estante Externo	Prateleira Central Shelf Central Estante Central	Prateleira Externa Shelf External Estante Externo
1200mm	GUA3746	GUA3746C	GUA3746
1400mm	GUA4746	GUA3746C	GUA4746
1600mm	GUA3846	GUA7646C	GUA3846

GUARDARE

ARMÁRIO| CABINET | ARMARIO

02 portas, 01 gaveta e 01 pasta | 02 doors, 01 drawer and 01 folder | 02 puertas y 06 cajones bajo

Vista superior
Top View | Vista superior

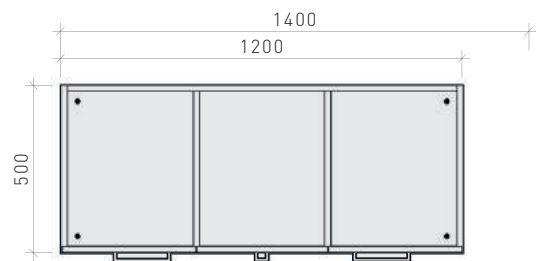
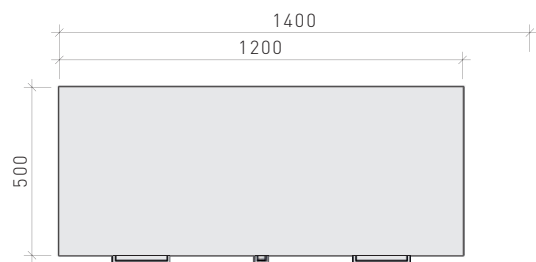

Vista frontal
Front View | Vista frontal

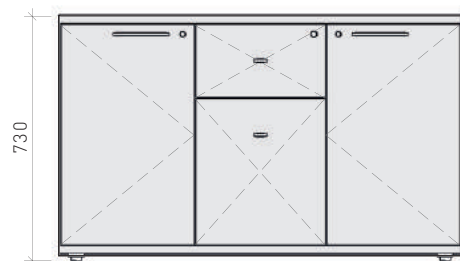

ARMÁRIO| CABINET | ARMARIO

04 portas baixo | 04 doors low | 04 puertas bajo

Vista superior
Top View | Vista superior

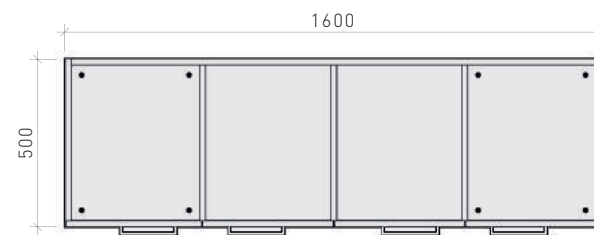
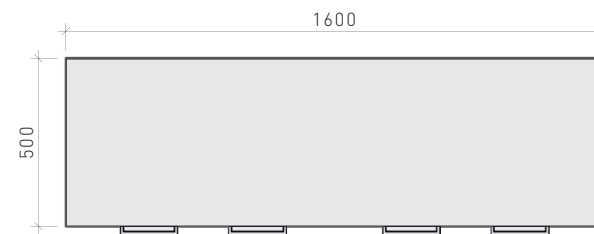

Vista frontal
Front View | Vista frontal

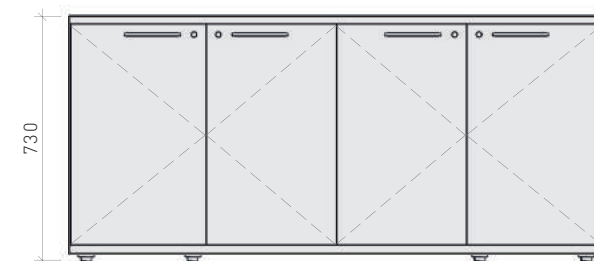

Prateleira Externa	Prateleira Central	Prateleira Central	Prateleira Externa
Shelf External	Shelf Central	Shelf Central	Shelf External
Estante Externo	Estante Central	Estante Central	Estante Externo
GUA3846	GUA3746C	GUA3746C	GUA3846

ARMÁRIO| CABINET | ARMARIO - 02 portas e 06 gavetas baixo
 02 doors and 06 drawers low | 02 puertas y 06 cajones abajo

Vista superior
 Top View | Vista superior

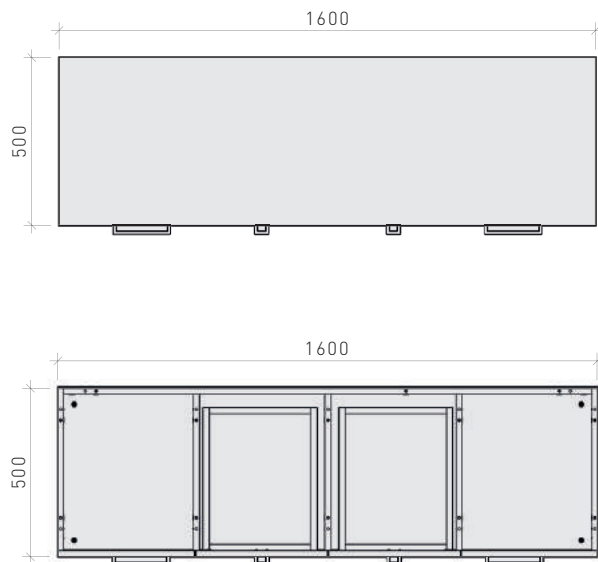

ARMÁRIO| CABINET | ARMARIO - 02 portas, 02 gavetas e 02 pastas baixo
 02 doors, 02 drawers and 02 folders low | 02 puertas, 02 cajones y 02 archivos bajo

Vista superior
 Top View | Vista superior

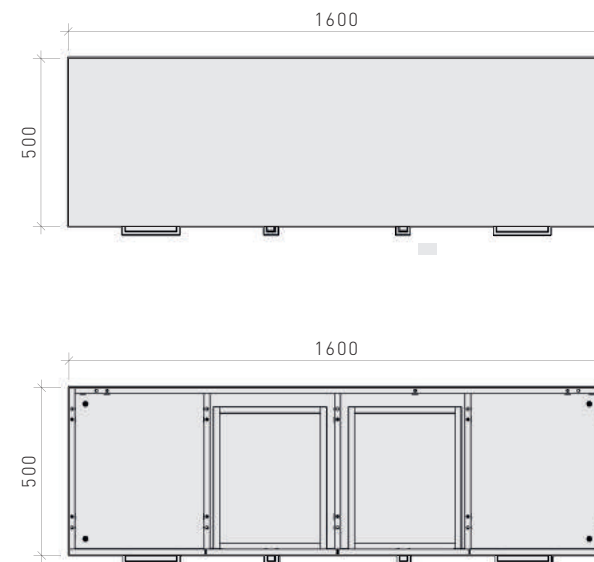

Vista frontal
 Front View | Vista frontal

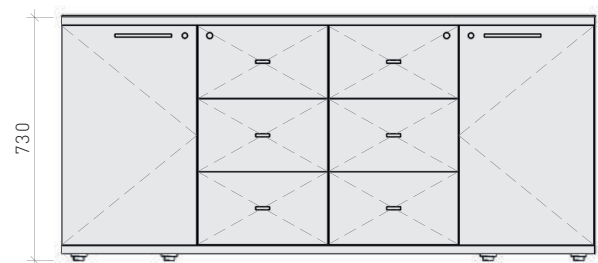

Vista frontal
 Front View | Vista frontal







GUARDARE

GAVETEIRO | CHEST OF DRAWERS | CAJONERA - Volante 03 gavetas baixo e médio
 Volant 03 drawers low and medium | Móvil 03 cajones bajo y mediano

GAVETEIRO | CHEST OF DRAWERS | CAJONERA - Volante 01 gaveta e 01 pasta baixo e médio
 Volant 01 drawer and 01 folder low and medium | Móvil 01 cajón y 01 archivo, bajo y mediano

Vista superior
Top View | Vista superior

Vista frontal
Front View | Vista frontal

Vista superior
Top View | Vista superior

Vista frontal
Front View | Vista frontal

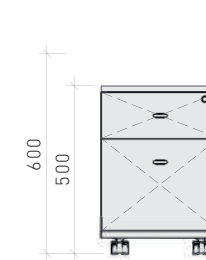
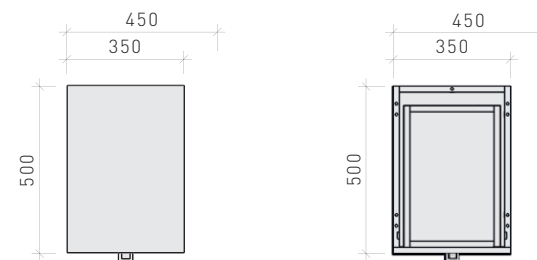
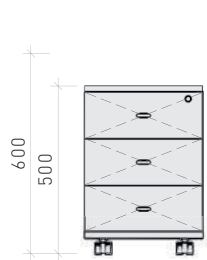
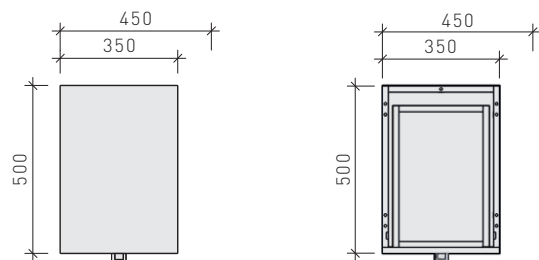

GAVETEIRO | CHEST OF DRAWERS | CAJONERA - Volante 04 gavetas médio
 Volant 04 drawers medium | Móvil 04 cajones mediano

GAVETEIRO | CHEST OF DRAWERS | CAJONERA - Volante 02 gavetas e 01 pasta médio
 Volant 02 drawers and 01 folder medium | Móvil 02 cajones y 01 archivo, mediano

Vista superior
Top View | Vista superior

Vista frontal
Front View | Vista frontal

Vista superior
Top View | Vista superior

Vista frontal
Front View | Vista frontal

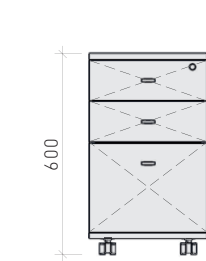
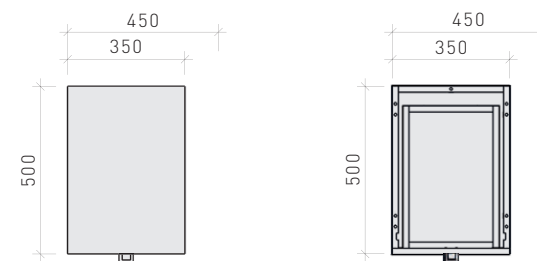
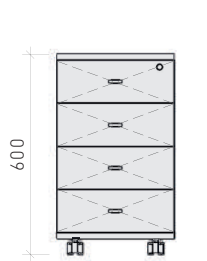
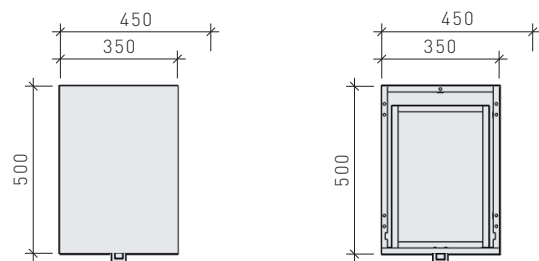

Quando o puxador for modelo cava, a lateral do gaveteiro será recuada, para a frente servir de puxador
 When the handle is cava model, the side of the drawer is retracted, so the front serve as a handle
 Cuando el tirador sea del modelo cava, la lateral de la cajonera será retrocedida, para que la frente sirva de tirador

GAVETEIRO | CHEST OF DRAWERS | CAJONERA - Fixo 03 gavetas médio
 Fixed 03 drawers medium | Fija 03 cajones mediana

Vista superior
 Top View | Vista superior

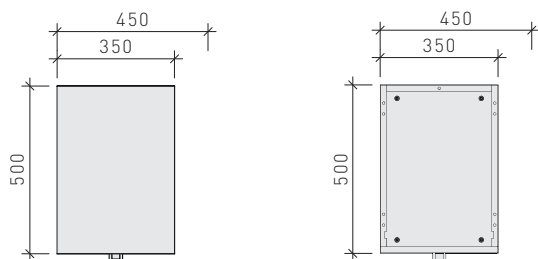

Vista frontal
 Front View | Vista frontal

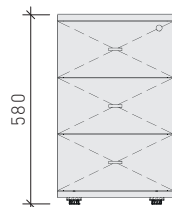

GAVETEIRO | CHEST OF DRAWERS | CAJONERA - Fixo 01 gaveta e 01 pasta médio
 Fixed 01 drawer and 01 folder medium | Fija 01 cajón y 01 archivo, mediana

Vista superior
 Top View | Vista superior

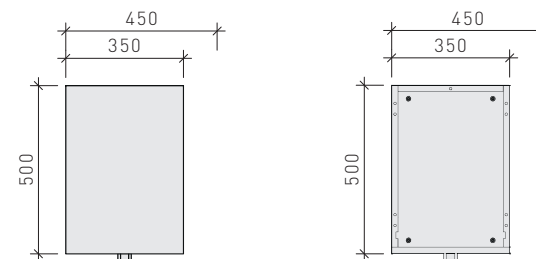

Vista frontal
 Front View | Vista frontal

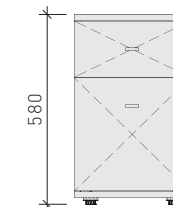

GAVETEIRO | CHEST OF DRAWERS | CAJONERA - Fixo 04 gavetas médio
 Fixed 04 drawers medium | Fija 04 cajones mediana

Vista superior
 Top View | Vista superior

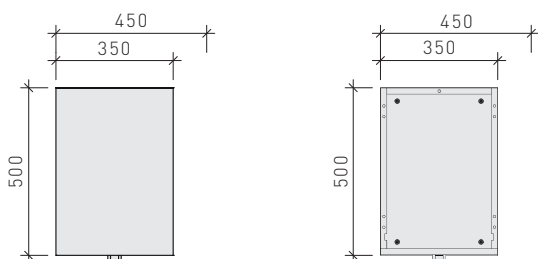

Vista frontal
 Front View | Vista frontal

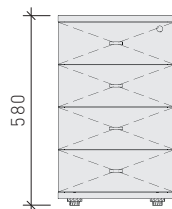

GAVETEIRO | CHEST OF DRAWERS | CAJONERA | Fixo 02 gavetas e 01 pasta médio
 Fixed 02 drawers and 01 folder medium | Fija 02 cajones y 01 archivo mediana

Vista superior
 Top View | Vista superior

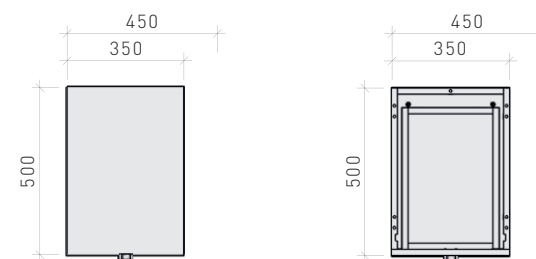

Vista frontal
 Front View | Vista frontal

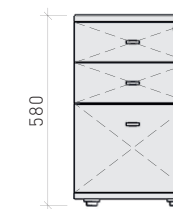

GUARDARE

GAVETEIRO | CHEST OF DRAWERS | CAJONERA

Fixo 04 gavetas alto | Fixed 04 drawers high | Fija 04 cajones alta

Vista superior
Top View | Vista superior

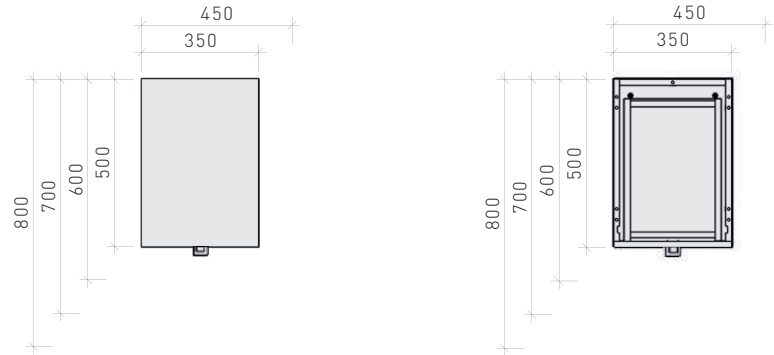

Vista frontal
Front View | Vista frontal

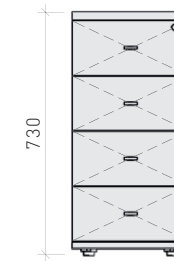

GAVETEIRO | CHEST OF DRAWERS | CAJONERA

Fixo 02 gavetas e 01 pasta alto | Fixed 02 drawer and 01 folder high | Fija 02 cajones y 01 archivo, alta

Vista superior
Top View | Vista superior

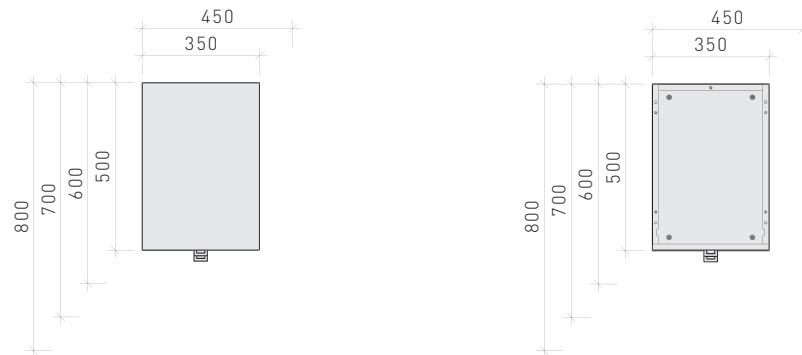

Vista frontal
Front View | Vista frontal

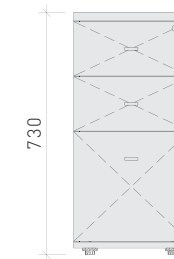

GAVETEIRO | CHEST OF DRAWERS | CAJONERA

Suspenso 01 gaveta | Suspended 01 drawer | Suspendida 01 cajón

Vista superior
Top View | Vista superior

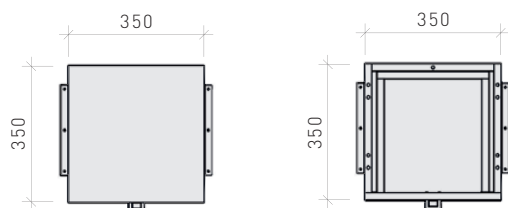

Vista frontal
Front View | Vista frontal

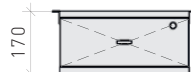

Vista superior
Top View | Vista superior

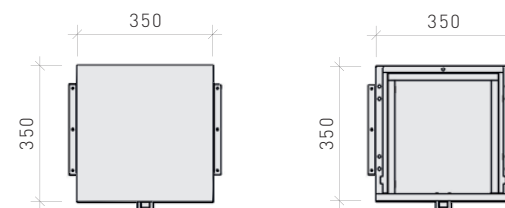

Vista frontal
Front View | Vista frontal

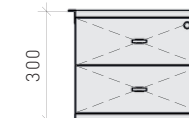

GAVETEIRO | CHEST OF DRAWERS | CAJONERA

Suspenso Távola 01 gaveta | Suspended Távola 01 drawer | Suspendida Távola 01 cajón

Vista superior
Top View | Vista superior

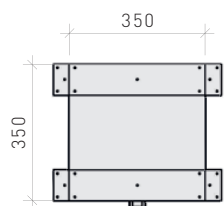

Vista frontal
Front View | Vista frontal

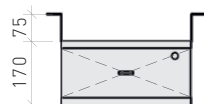

Vista superior
Top View | Vista superior

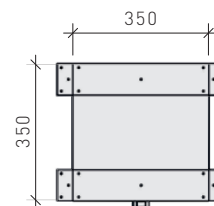

Vista frontal
Front View | Vista frontal

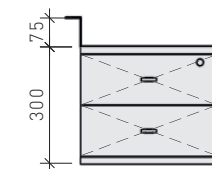

GAVETEIRO | CHEST OF DRAWERS | CAJONERA

Suspenso 02 gavetas | Suspended 02 drawers | Suspendida 02 cajones

GAVETEIRO | CHEST OF DRAWERS | CAJONERA

Suspenso Távola 02 gavetas | Suspended Távola 02 drawers | Suspendida Távola 02 cajones

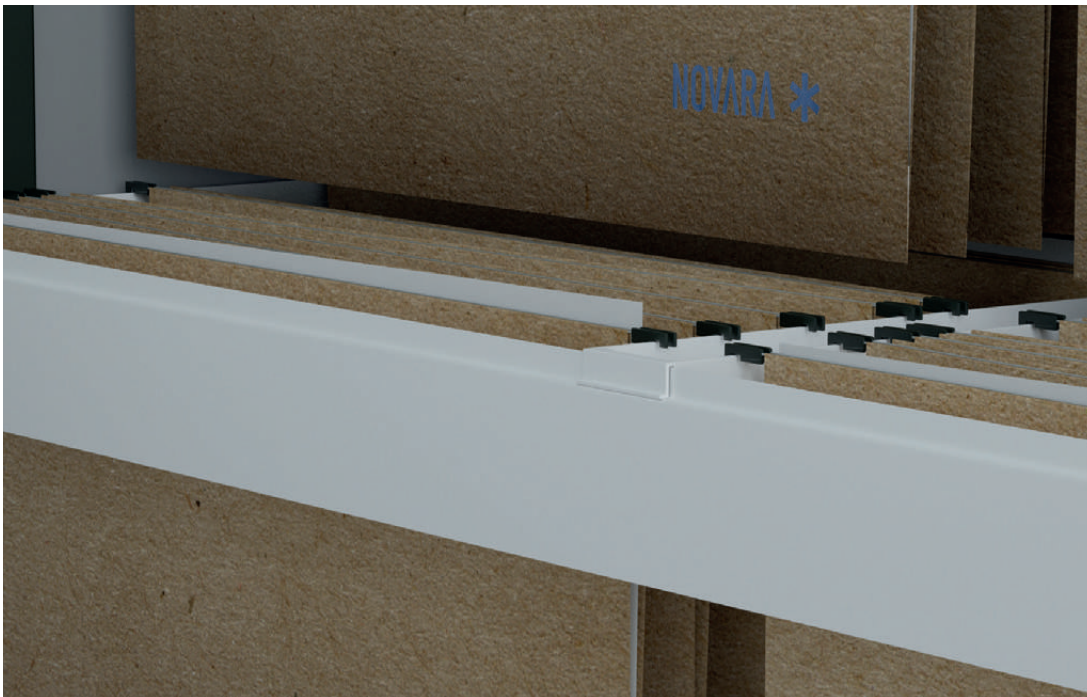
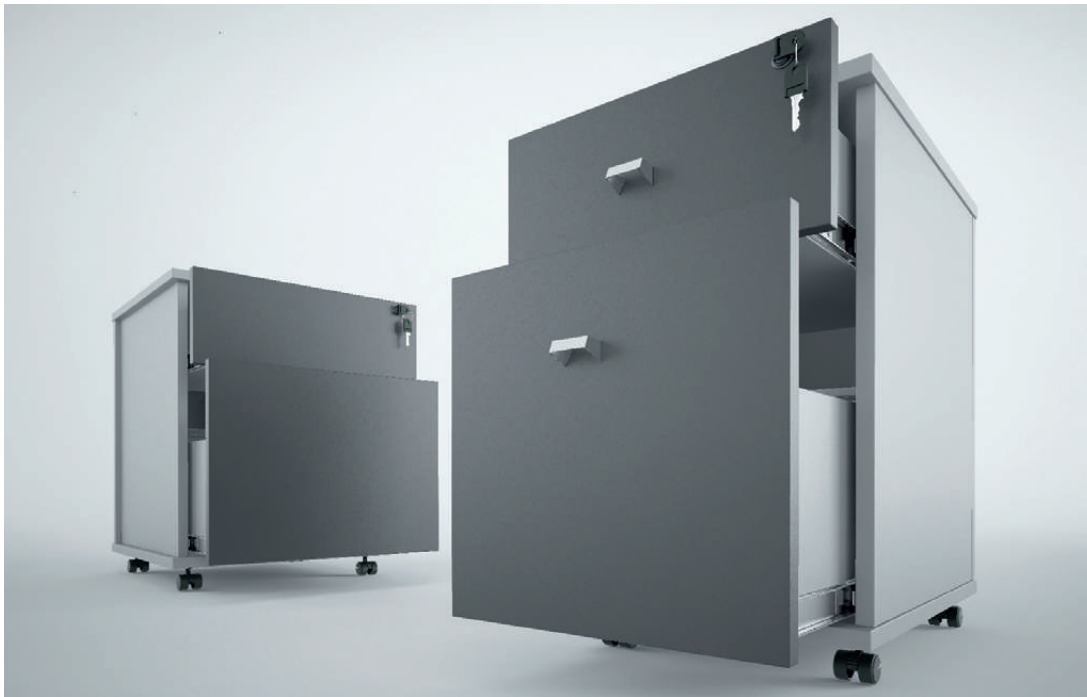

ACESSÓRIO | ACCESSORY | ACCESORIO

Pasta suspensa | Suspended folder | Archivo suspendido

Vista superior
Top View | Vista superior

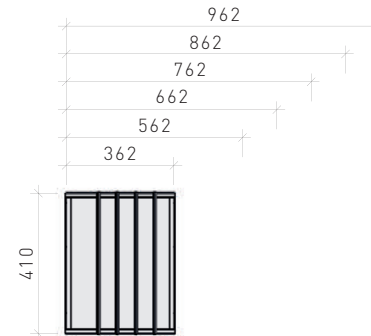

Vista frontal
Front View | Vista frontal

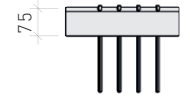

ACESSÓRIO | ACCESSORY | ACCESORIO - Acessório inverter pasta suspensa

Accessory inverter suspended folder | Accesorio invertir archivo suspendido

Vista superior
Top View | Vista superior

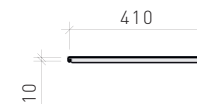

Vista frontal
Front View | Vista frontal



ACESSÓRIO | ACCESSORY | ACCESORIO

Prateleira interna armários | Internal shelf cabinets | Estante interno armarios

ACESSÓRIO | ACCESSORY | ACCESORIO

Prateleira interna armários | Internal shelf cabinets | Estante interno armarios

Vista superior
Top View | Vista superior

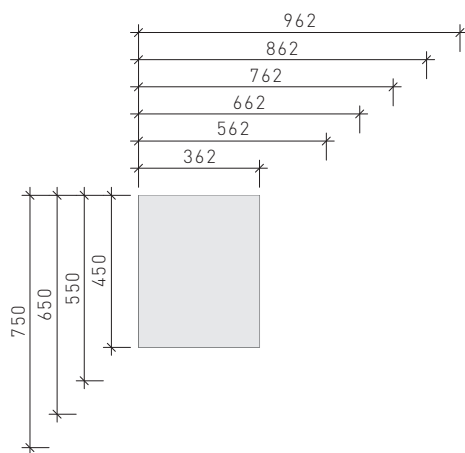

Vista frontal
Front View | Vista frontal



Vista superior
Top View | Vista superior

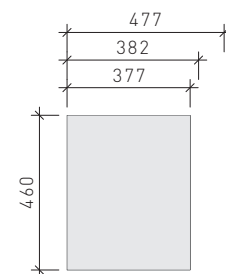

Parte externa credenza
External part credenza
Parte externa credenza

Vista superior
Top View | Vista superior

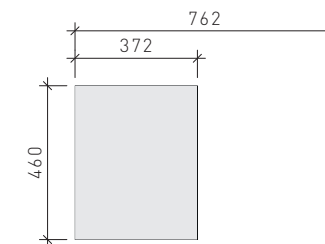

Parte central credenza
Central part credenza
Parte central credenza

ACESSÓRIO | ACCESSORY | ACCESORIO

Tampo superior armários | Top panel cabinets | Tapa superior armarios

ACESSÓRIO | ACCESSORY | ACCESORIO - Assento para gaveteiro

Seat for chest of drawers | Asiento para cajonera

Vista superior
Top View | Vista superior

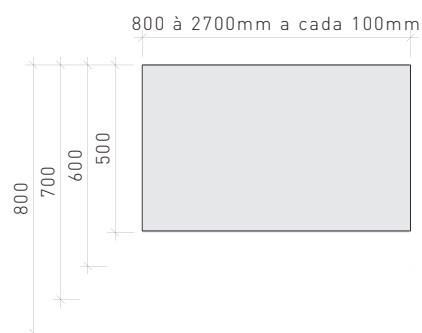

Vista frontal
Front View | Vista frontal



Vista superior
Top View | Vista superior

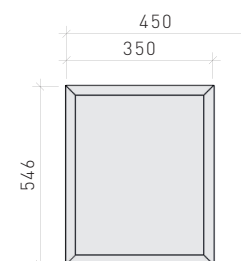

Vista frontal
Front View | Vista frontal



GUARDARE

METAIS | METAL | METALES

BP LISOS | BP SMOOTH | BP LISOS



Argila
Clay | Arcilla



Preto
Black | Negro



Cinza flex perlizado
Pearlescent grey flex | Gris flex perlado



Argila
Clay | Arcilla



Preto
Black | Negro

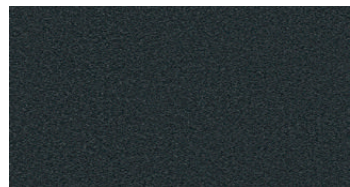

Grafite
Graphite | Grafito

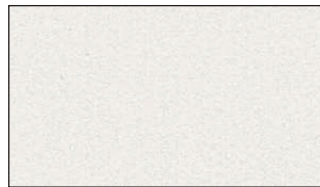

Branco
White | Blanco

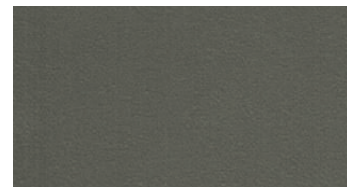

Cinza Urano
Uranus Grey | Gris Urano

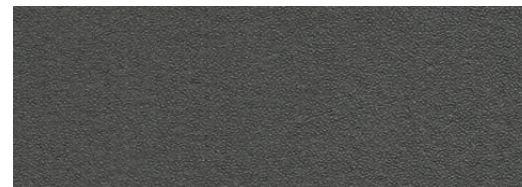

Grafite
Graphite | Grafito

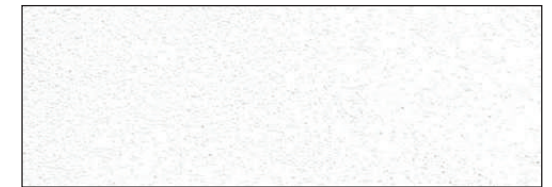

Branco
White | Blanco

BP MADEIRADOS



Carvalho Munique | Munich Oak | Roble Munique

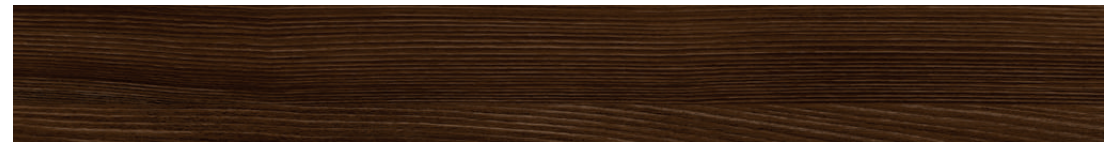

Rovere Marsala | Rovere Marsala | Rovere Marsala

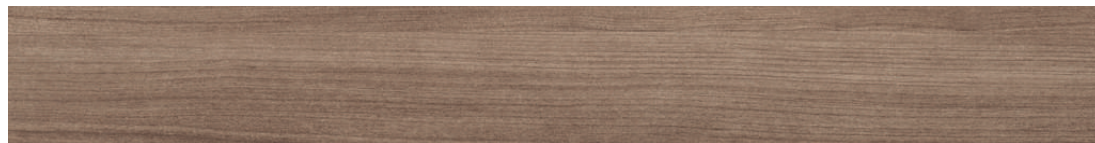

Noce Amendoa | Noce Almond | Noce Almendra



Carvalho Prata | Silver Oak | Roble Plata

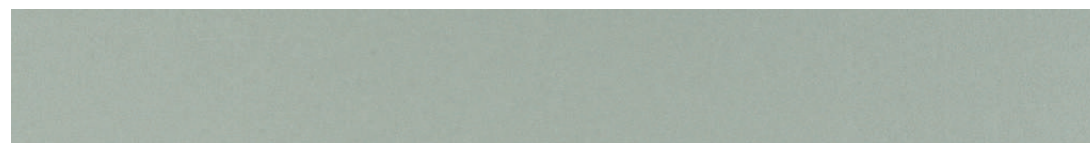

Cinza Matrix | Grey Matrix | Gris Matrix



Rua | Street | Calle: Evaristo de Antoni - 3013 - Caxias do Sul - RS
CEP | Zip Code | Código Postal: 95041-000
Fone | Phone | Teléfono: (+55 54) 3027.1818
www.novara.ind.br -  /novaramoveis



A marca do manejo
florestal responsável